



**Pioneer
PX Series Balances
Instruction Manual**

**Pioneer
Balanzas Serie PX
Manual de Instrucciones**

**Pionnier
Balance de Séries PX
Manuel d'instruction**

**Pioneer
PX-Serie Waagen
Bedienungsanleitung**

**Bilance
Pioneer Serie PX
Manuale di Istruzioni**



Table of Contents

1. INTRODUCTION	EN-3
1.1 Description	EN-3
1.2 Features	EN-3
1.3 Definition of Signal Warnings and Symbols	EN-3
1.4 Safety Precautions	EN-3
2. INSTALLATION	EN-4
2.1 Unpacking	EN-4
2.2 Select the Location	EN-4
2.3 Leveling	EN-4
2.4 Connecting Power and Acclimating the Balance	EN-5
2.5 Connecting the Interface	EN-5
2.6 Initial Calibration	EN-5
3. OPERATION	EN-6
3.1 Overview of Display, Home Screen	EN-6
3.2 Principal Functions and Main Menu	EN-7
3.3 Overview of Parts and Features – Draft Shield Models	EN-7
3.4 Overview of Parts and Features – Non-Draft Shield Models	EN-7
4. APPLICATIONS	EN-8
4.1 Weighing	EN-8
4.2 Parts Counting	EN-8
4.3 Percent Weighing	EN-10
4.4 Dynamic Weighing	EN-11
4.5 Density Determination	EN-12
4.5.1 Measuring the Density of a Sinking Solid Using Water	EN-13
4.5.2 Measuring the Density of a floating Solid Using Water	EN-14
4.5.3 Measuring the Density of a Solid Using an Auxiliary Liquid other than Water	EN-15
4.5.4 Measuring the Density of a Liquid Using a Calibrated Sinkers	EN-16
4.5.5 Measuring the Density of Porous Material Using Oil	EN-17
4.6 Additional Features	EN-19
5. MENU SETTINGS	EN-20
5.1 Menu Navigation	EN-20
5.1.1 Changing Settings	EN-20
5.2 Calibration	EN-20
5.2.1 Calibration Sub-menu (InCal models)	EN-21
5.2.2 Internal Calibration (not applicable to ExCal models)	EN-21
5.2.3 InCal Adjust (not applicable to ExCal models)	EN-21
5.2.4 Span Calibration	EN-22
5.2.5 Linearity Calibration	EN-23
5.3 Balance Setup	EN-24
5.3.1 Language	EN-24
5.3.2 Filter Level	EN-25
5.3.3 AZT (Auto Zero Tracking)	EN-25
5.3.4 Auto Tare	EN-25
5.3.5 Graduations	EN-25
5.3.6 Date Format	EN-25
5.3.7 Date Setup	EN-25
5.3.8 Time Format	EN-25
5.3.9 Time Setup	EN-25
5.3.10 Brightness	EN-26
5.3.11 Auto Dim	EN-26
5.3.12 Capacity Bar	EN-26
5.3.13 Approved Mode	EN-26
5.4 Weighing Units	EN-27
5.5 RS232 Interface Setup	EN-29
5.5.1 Baud Rate	EN-29
5.5.2 Transmission	EN-29

5.5.3	Handshake	EN-29
5.6	Print Settings	EN-29
5.6.1	Stable Only	EN-29
5.6.2	Numeric Only	EN-29
5.6.3	Single Header	EN-29
5.6.4	Print To	EN-29
5.6.5	Auto Print	EN-30
5.6.6	Header	EN-30
5.6.7	Date and Time	EN-30
5.6.8	Balance ID	EN-30
5.6.9	Balance Name	EN-30
5.6.10	User Name	EN-30
5.6.11	Project Name	EN-30
5.6.12	Application Name	EN-30
5.6.13	Result	EN-30
5.6.14	Gross	EN-30
5.6.15	Net	EN-30
5.6.16	Tare	EN-31
5.6.17	Line Feed	EN-31
5.7	GLP	EN-31
5.7.1	Header	EN-31
5.7.2	Balance Name	EN-31
5.7.3	User Name	EN-31
5.7.4	Project Name	EN-31
5.8	Factory Reset	EN-31
5.9	Lockout	EN-31
6.	LEGAL FOR TRADE (LFT)	EN-32
6.1	Settings	EN-32
6.2	Verification	EN-32
6.3	Securing the Menu	EN-32
6.4	Sealing Access to the Balance Settings	EN-32
7.	Printing	EN-33
7.1	Connecting, Configuring and Testing the Printer / Computer Interface	EN-33
7.2	Output Format	EN-34
7.3	Printout Examples	EN-34
8.	MAINTENANCE	EN-36
8.1	Calibration	EN-36
8.2	Cleaning	EN-36
8.3	Troubleshooting	EN-36
8.4	Service Information	EN-36
9.	TECHNICAL DATA	EN-37
9.1	Specifications	EN-37
9.2	Drawings and Dimensions	EN-43
9.3	Accessories	EN-43
9.4	Communication	EN-44
9.4.1	Interface Commands	EN-44
9.4.2	RS232 (DB9) Pin Connections	EN-45
9.4.3	USB Interface	EN-45
9.4.4	USB Connection	EN-46
10.	SOFTWARE UPDATES	EN-46
11.	COMPLIANCE	EN-47

1. INTRODUCTION

1.1 Description

The PX balance is a precision weighing instrument that will provide you with years of service if properly cared for. PX balances are available in capacities from 82 grams to 8200 grams.

1.2 Features

Operation Controls: 2-line backlit display, with 6 weighing applications and many other features.



1.3 Definition of Signal Warnings and Symbols

Safety notes are marked with signal words and warning symbols. These show safety issues and warnings. Ignoring the safety notes may lead to personal injury, damage to the instrument, malfunctions and false results.

- WARNING** For a hazardous situation with medium risk, possibly resulting in injuries or death if not avoided.
- CAUTION** For a hazardous situation with low risk, resulting in damage to the device or the property or in loss of data, or injuries if not avoided.
- Attention Note** For important information about the product
For useful information about the product

Warning Symbols



General Hazard



Electrical Shock Hazard



Alternating Current



Direct Current

1.4 Safety Precautions



CAUTION: Read all safety warnings before installing, making connections, or servicing this equipment. Failure to comply with these warnings could result in personal injury and/or property damage. Retain all instructions for future reference.

- Verify that the AC adapter's input voltage range and plug type are compatible with the local AC main power supply.
- Make sure that the power cord does not pose a potential obstacle or tripping hazard.
- Do not position the balance such that it is difficult to reach the power connection.
- The balance is for indoor use only. Do not operate the equipment in hazardous or unstable environments.
- Operate the equipment only under ambient conditions specified in these instructions.
- Do not drop loads on the pan.
- Use the balance only in dry locations.
- Disconnect the equipment from the power supply when cleaning.
- Use only approved accessories and peripherals.
- Service should only be performed by authorized personnel.

2. INSTALLATION

2.1 Unpacking

Carefully remove your PX balance and each of its components from the package. The included components vary depending on the balance model (see the list below). Save the packaging to ensure safe storage and transport. Please read the manual completely before installing and using the PX balance to avoid incorrect operation.

Components included:

- Balance
- Power adapter + Attaching plug
- Stainless steel pan
- Pan support (for 0.1 g / 0.01 g model only)
- Warranty card

2.2 Select the Location

Avoid heat sources, rapid temperature changes, air current or excessive vibrations. Allow sufficient space.

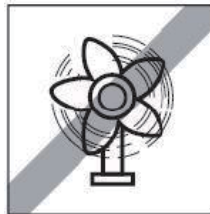
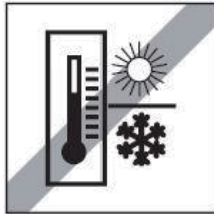
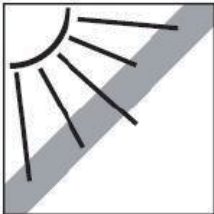

2.3 Leveling

Be sure the balance is level before it is used or after its location is changed.

The PX balance has a level bubble in a small round window beside the display.

To level the balance, adjust the 4 Leveling Feet until the bubble is centered in the circle.

Please refer to Figure 2-1 for leveling.

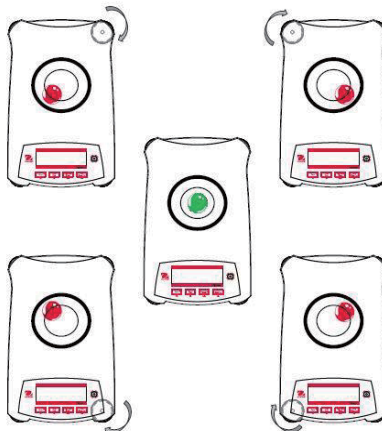

Figure 2-1. Leveling

2.4 Connecting Power and Acclimatising the Balance

Connect the DC output connector to the power receptacle on the rear of the balance. Then connect the AC adapter plug to a suitable electrical outlet.

Acclimatising

It is suggested that the balance should not be used until it has been connected to power and acclimatised to the environment for a certain period of time. In the case of a balance with the precision above 0.1 mg, the acclimatisation time should be 1.5 hours; in the case of balance with the precision of 0.01 mg, the acclimatisation time should be more than 4 hours.

2.5 Connecting the Interface

The PX balance has two data interfaces, RS232 and USB.

Use the RS-232 port to connect either to a computer or a printer with a standard (straight-through) serial cable.

Use the USB port to connect to a computer with a USB 2.0 Type A to Type B cable.

Interface connections on the rear of the balance



USB: Used to connect to PC only

RS232: Used to connect to PC or Printer

Note: For Connecting, Configuring and Testing the Printer / Computer Interface, see the Printing section.

2.6 Initial Calibration

When the PX balance is first installed, or when it is moved to another location, it must be calibrated to ensure accurate weighing results. PX balances are classified into two categories, InCal models and ExCal models. InCal models have a built-in calibration mechanism which can calibrate the balance automatically and does not require the use of external calibration masses. If preferred, InCal models can also be manually calibrated with external masses. ExCal models are calibrated with external masses. Make sure to have the appropriate calibration masses available before beginning calibration.

3. OPERATION

3.1 Overview of Display, Home Screen

The PX balance has a 2-line backlit display.

CONTROLS

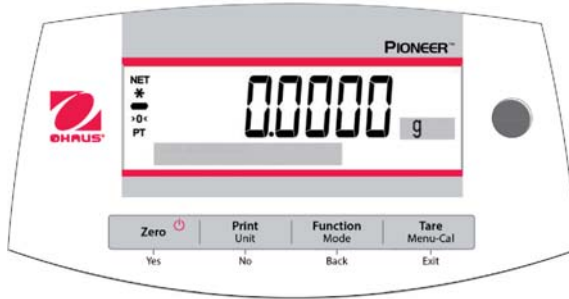

CONTROL FUNCTIONS

Button	<div style="border: 1px solid black; padding: 5px; text-align: center;"> Zero </div> <p style="text-align: center;">Yes</p>	<div style="border: 1px solid black; padding: 5px; text-align: center;"> Print Unit </div> <p style="text-align: center;">No</p>	<div style="border: 1px solid black; padding: 5px; text-align: center;"> Function Mode </div> <p style="text-align: center;">Back</p>	<div style="border: 1px solid black; padding: 5px; text-align: center;"> Tare Menu-Cal </div> <p style="text-align: center;">Exit</p>
Primary Function (Short Press) 	<p style="text-align: center;">On / Zero</p> <ul style="list-style-type: none"> If the Indicator is Off, turns on the Indicator. If Indicator is On, sets zero. 	<p style="text-align: center;">Print</p> <ul style="list-style-type: none"> Sends the current displayed value to the serial interface. 	<p style="text-align: center;">Function</p> <ul style="list-style-type: none"> Operation is dependent on the application mode. 	<p style="text-align: center;">Tare</p> <ul style="list-style-type: none"> Performs tare operation.
Secondary Function (Press and Hold) 	<p style="text-align: center;">Off</p> <ul style="list-style-type: none"> Zeroing current value. 	<p style="text-align: center;">Unit</p> <ul style="list-style-type: none"> Changes weighing units. 	<p style="text-align: center;">Mode</p> <ul style="list-style-type: none"> Changes application mode. 	<p style="text-align: center;">Menu-Cal</p> <ul style="list-style-type: none"> Enters the main menu. Calibration is the first sub-menu. Views the preset Tare value.
Menu Function (Short Press) 	<p style="text-align: center;">Yes</p> <ul style="list-style-type: none"> Accepts the current (blinking) setting on the display. 	<p style="text-align: center;">No</p> <ul style="list-style-type: none"> Rejects the current (blinking) setting on the display. Increments a value being entered. 	<p style="text-align: center;">Back</p> <ul style="list-style-type: none"> Reverts back to previous menu item. Decrements a value being entered. 	<p style="text-align: center;">Exit</p> <ul style="list-style-type: none"> Immediately exits the sub-menu. Aborts a calibration in progress.

MAIN APPLICATION SCREEN



3.2 Principal Functions and Main Menu

- Weighing:** Press **Zero** to set the display to zero. Place an object on the pan. The display indicates the gross weight.
- Taring:** With no load on the pan, press **Zero** to set the display to zero. Place an empty container on the pan and press **Tare**. Add material to the container and its net weight is displayed. After the container and the objects are removed, the load will be displayed as a negative number. Press **Tare** to clear.
- Zero:** Press **Zero** to zero the balance.
- Dot-matrix Display:** The relevant data in the specific application mode are shown in the dot-matrix display area.

3.3 Overview of Parts and Features – Draft Shield Models

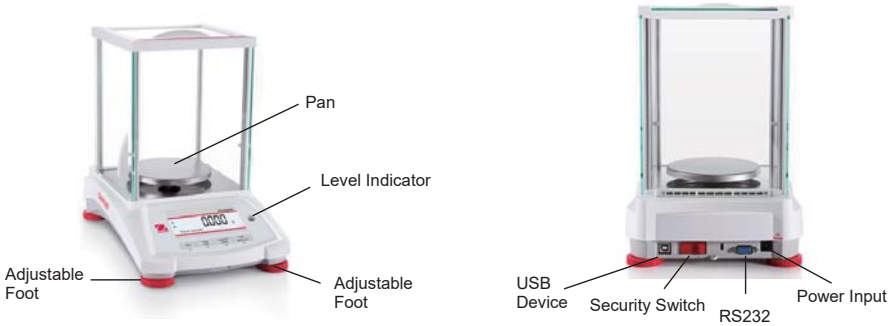

3.4 Overview of Parts and Features – Non-Draft Shield Models

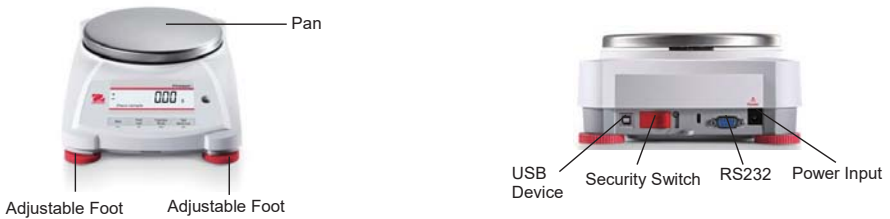

4. APPLICATIONS

The PX balance can be operated in 6 application modes by long pressing the **Function / Mode** button.

4.1 Weighing

Note: Before using any application, be sure the balance has been leveled and calibrated.

Use this application to determine the weight of objects in the selected unit of measure.

Weighing

1. Press **Tare** or **Zero** if necessary to begin.
2. Press and hold the **Function / Mode** button to select *Weighing* (this application is the default).
3. Place objects on the pan to display the weight. Once the reading is stable, the * will appear.
4. The resulting value is displayed in the active unit of measure.

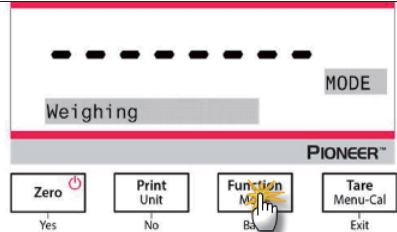

Item Settings

To view or adjust the current settings.

- **Capacity Bar:** When set to On, the capacity bar is displayed in the reference field. The capacity will not display when the balance is set to zero.
- **Weighing Units:** Change the displayed unit. See Section 5.4 for more information.
- **Filter Level:** Change Filtering level. See Section 5.3.2 for more information.
- **GLP Data:** See Section 5.7 for more information.
- **Print Settings:** Change printing settings. See Section 7 for more information.

4.2 Parts Counting

Note: Before using any application, be sure the balance has been leveled and calibrated. The minimum piece weight should be no less than 0.1d. In the LFT mode, the minimum piece weight is 3e, the minimum Sample Size is 10.

Use this application to count samples of uniform weight.

Parts Counting

1. Press **Tare** or **Zero** if necessary to begin.
2. Press and hold the **Function / Mode** button until *Parts Counting* appears.

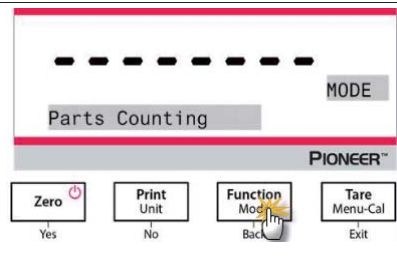

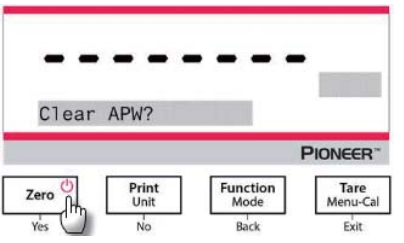
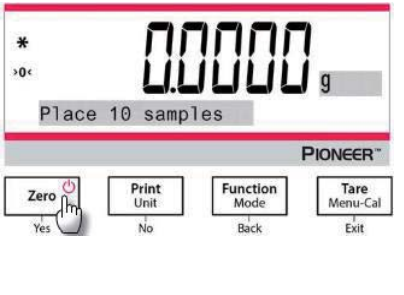
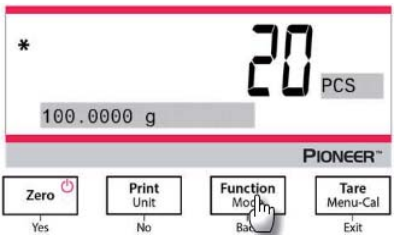
<ol style="list-style-type: none"> After confirmation by pressing Yes, the message "Clear APW?" will appear on the screen. If the APW of the last Parts Counting operation needs to be kept, press No when the message "Clear APW?" displays. 	
<ol style="list-style-type: none"> Press Yes, and the message "Sample size 10" will display with the numeral "10" (default) flashing. Confirm the sample size by pressing Yes, and place 10 samples on the pan to display the weight. Press No or Back to increase or decrease the value as desired. Press the Function / Mode button so that the weight of the 10 samples is used to establish the average piece weight (APW). The display will show 10 pieces. To view the piece weight or the total weight, press the Function / Mode button. 	
<ol style="list-style-type: none"> Place additional objects on the pan, and the corresponding number of pieces will display. 	

Item Settings

Sample: The sample size ranges from 1 to 1000. The default value is 10.

Note: To ensure accurate counting, the minimum piece weight should be no less than 0.1d.

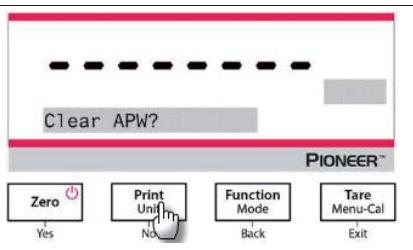

APW Optimization:
 Improving counting accuracy by re-calculating the piece weight automatically as parts are added.

APW Optimization occurs only when the number of pieces added to the pan is between one and three times the number already on the pan.

Print Settings:
 Changing printing setup. See Section 7 for more information.

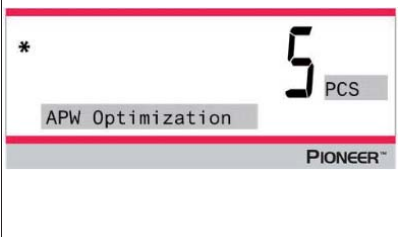

4.3 Percent Weighing

Note: Before using any application, be sure the balance has been leveled and calibrated.

Use Percent Weighing to display the weight of a test object as a percentage of a pre-established reference sample.

The default (or last) reference weight is displayed.

Percent Weighing

1. Press and hold the **Function / Mode** button until *Percent Weighing* appears.
2. After confirmation by pressing **Yes**, the message "Clear reference?" will appear on the screen.
3. Press **Yes**, and then the message "Place sample" will display.
4. Place the reference sample on the pan to display the weight. When the reading is stable, the * will appear.
5. Press the **Function / Mode** button so that the weight of the reference sample is stored in memory. The display will show 100%.

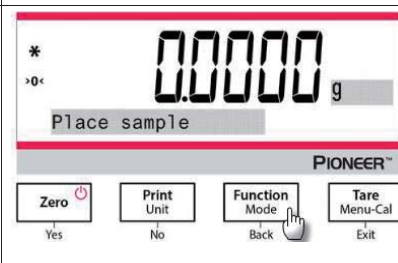
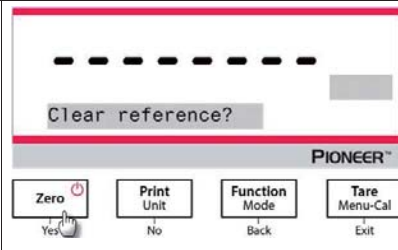
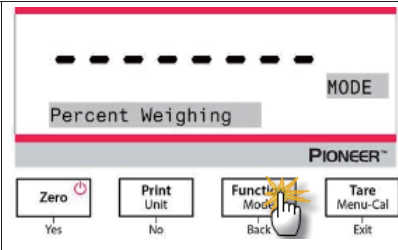

6. Remove the reference sample and place the test object on the pan. The ratio of the test object to the reference sample weight is displayed as a percentage.
7. To view the reference sample weight or the test object weight, press the **Function / Mode** button.

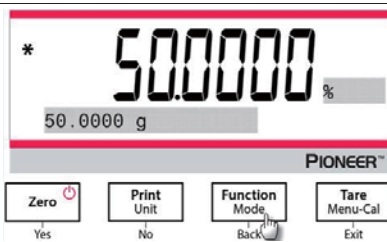

Item Settings

Note:

If the previously established reference sample weight needs to be kept, press **No** when the message "Clear reference?" displays.

Printing Setup:

Changing printing setup. See Section 7 for more information.

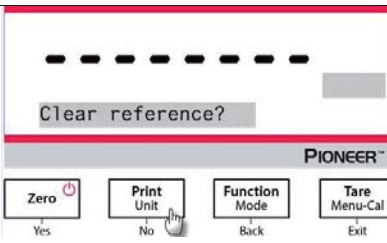

4.4 Dynamic Weighing

Note: Before using any application, be sure the balance has been leveled and calibrated. Clear the pan before beginning a new Dynamic Weighing cycle.

Use this application to weigh an unstable load, such as a moving animal.

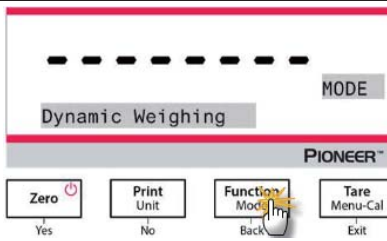

Dynamic Weighing

1. Press and hold the **Function / Mode** button until *Dynamic Weighing* appears.
2. After confirmation by pressing **Yes**, the message "Change parameter?" will appear on the screen.

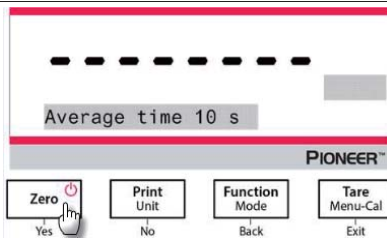

3. Press **Yes**, and then the message "Average time 10 s" will display with the numeral "10" flashing. Press **No** or **Back** to increase or decrease the value as desired.

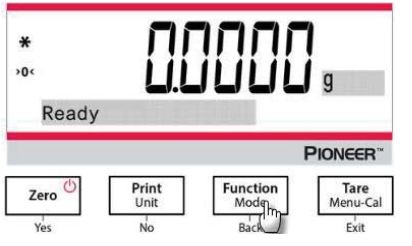

<p>4. Confirm the weighing time by pressing Yes, and the message "Ready" will display at the lower left of the screen.</p>	
<p>5. Place the dynamic object on the pan. The balance begins a countdown (averaging process). During the countdown, the screen shows the time remaining.</p>	
<p>6. When the countdown ends, the result line is displayed and held.</p> <p>7. After the dynamic object is removed, the weight will be automatically set to zero, and the balance will return to the status of "Ready".</p>	

Item Settings

- Averaging Time:** Set the averaging time to a value between 1 and 15 seconds. Default is 10 seconds.
- Printing Setup:** Changing printing setup. See Section 7 for more information.

4.5 Density Determination

Note: Before using any application, be sure the balance has been leveled and calibrated.

Use this application to determine an object's density.

A **Density Determination Kit, Part Number 80253384**, is designed to be used with PX series balances. Illustrations in this procedure refer to the density kit, however, you may use whatever lab apparatus that will suit the requirements for density measurements. A built in reference density table for water at temperatures between 10°C and 30.9°C is included in the balance software. Review this entire section before attempting density measurements.

Operation Method

Press and hold the **Function / Mode** button until the Density appears on the screen.

After confirmation by pressing **Yes**, the message "Change parameter?" will display on the screen. The settings can be kept or changed as desired.

Item Settings:

- Sample Type: Solid, Liquid
- Auxiliary Liquid: Water, Alcohol, Other
- Porous Material: Off, On
- Water Temperature: 20°C (by default)
- Alcohol Temperature: 20°C (by default)
- Volume (of Calibrated Sinkers): 10 ml (by default)
- Weight (of Porous Material): 5.000 g

- Oil Density: 0.80000 g / cm³

Four types of density determination can be made:

1. Solid more density than the auxiliary liquid
2. Solid less density than the auxiliary liquid
3. Liquid density
4. Porous material (impregnated with oil)

The following are the operating procedures for determining density of solid, liquid and porous material with water as the auxiliary liquid. Other auxiliary liquids are also applicable for density determination.

4.5.1 Measuring the Density of a Sinking Solid Using Water

Press and hold the **Function / Mode** button until *Density* appears. Press **Yes** to initiate the *Density Determination*.

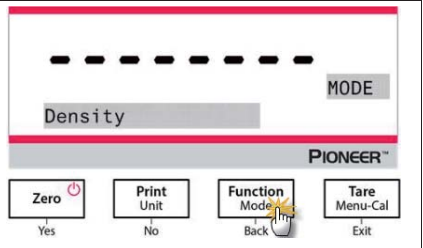

Item Settings:

- Sample type: Solid
- Auxiliary Liquid: Water
- Porous Material: Off
- Water Temperature: Measure the actual water temperature using a precision thermometer.

The water temperature is 20.0°C by default.

Press **No** or **Back** to increase or decrease the value of temperature. The balance calculates water density based on the water temperature value entered.

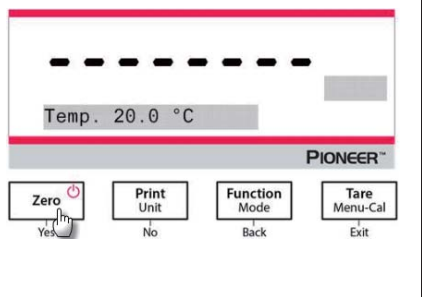





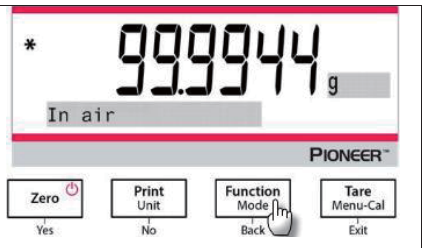

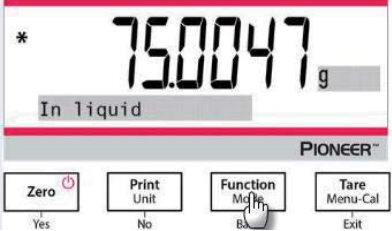
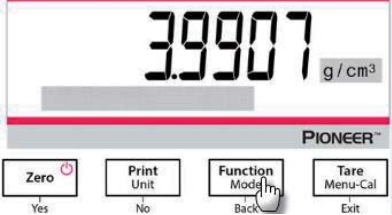
1. Weigh the sample in air using the balance and the density determination kit.

When the * (symbol of stability) appears, press the **Function / Mode** button to confirm the weight of the sample in the air.

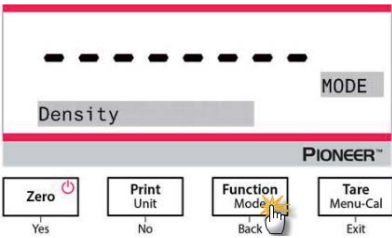

<p>2. Weigh the sample submerged in the liquid using the balance and the density determination kit. Note: Lower the sample down into the liquid until it is fully submerged.</p>	 <p>The screenshot shows the balance display with a red top bar. The main display shows a weight of 75.0047 g. Below the weight, it says 'In liquid'. The PIONEER logo is visible. At the bottom, there are four buttons: Zero (Yes), Print Unit (No), Function Mode (Back), and Tare Menu-Cal (Exit). A mouse cursor is pointing at the Function Mode button.</p>
<p>3. Press the Function / Mode button to get the density of the sample. After completion of the test, press the Function / Mode button to test a new sample.</p>	 <p>The screenshot shows the balance display with a red top bar. The main display shows a density of 3.9907 g/cm³. The PIONEER logo is visible. At the bottom, there are four buttons: Zero (Yes), Print Unit (No), Function Mode (Back), and Tare Menu-Cal (Exit). A mouse cursor is pointing at the Function Mode button.</p>

4.5.2 Measuring the Density of a floating Solid Using Water

<p>1. Press and hold the Function / Mode button until <i>Density</i> appears. Press Yes to enter the <i>Density Determination</i>.</p>	 <p>The screenshot shows the balance display with a red top bar. The main display shows 'Density' and 'MODE'. The PIONEER logo is visible. At the bottom, there are four buttons: Zero (Yes), Print Unit (No), Function Mode (Back), and Tare Menu-Cal (Exit). A mouse cursor is pointing at the Function Mode button.</p>				
<p>2. In determining density with the balance, the balance setup and density determination procedures are basically the same for a floating solid and a non-floating solid except for the necessary holder (as shown in the figure) to be used for density determination. 3. After completion of the test, press the Function / Mode button to test a new sample. Note: Lower the sample down into the liquid until it is fully submerged.</p>	<table border="1" style="width: 100%; text-align: center;"> <tr> <td data-bbox="621 906 834 1093">  </td> <td data-bbox="834 906 1049 1093">  </td> </tr> <tr> <td data-bbox="621 1093 834 1161"> <p>Holder for non-floating solids</p> </td> <td data-bbox="834 1093 1049 1161"> <p>Holder for floating solids</p> </td> </tr> </table>			<p>Holder for non-floating solids</p>	<p>Holder for floating solids</p>
					
<p>Holder for non-floating solids</p>	<p>Holder for floating solids</p>				

4.5.3 Measuring the Density of a Solid Using an Auxiliary Liquid other than Water

1. Press and hold the **Function / Mode** button until *Density* appears. Press **Yes** to enter the *Density Determination*.

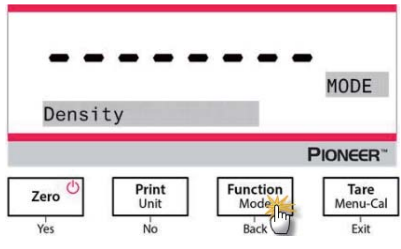

- Item Settings:**
- Sample type: Solid
 - Auxiliary Liquid: Other
 - Porous Material: Off

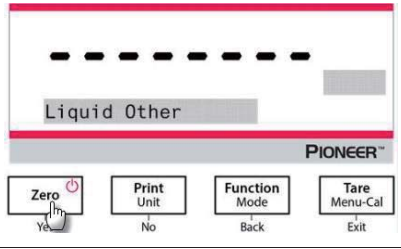

- Set the density of the auxiliary liquid:**
2. The default value of the auxiliary liquid is 1.00000 g/cm³.
 3. Press **No** or **Back** to increase or decrease the value in accordance with the actual density of the auxiliary liquid.

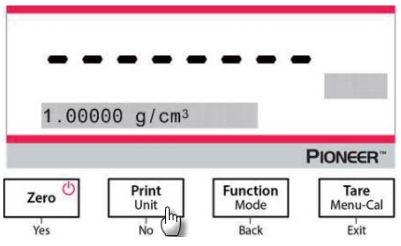

4. See Section 4.5.1 and Section 4.5.2 for the specific procedures for density determination.
5. Press the **Function / Mode** button to display the density of the sample.
6. After completion of the test, press the **Function / Mode** button to test a new sample.

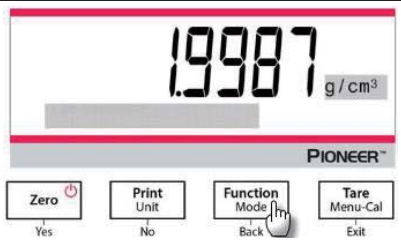

4.5.4 Measuring the Density of a Liquid Using a Calibrated Sinkers

Press and hold the **Function / Mode** button until *Density* appears. Press **Yes** to enter the *Density Determination*.

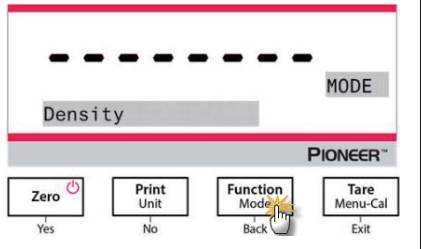

Item Settings:
 Sample Type: Liquid
 Volume: The calibrated sinker has a default volume of 10.0 ml, which can be increased or decreased by pressing **No** or **Back**.

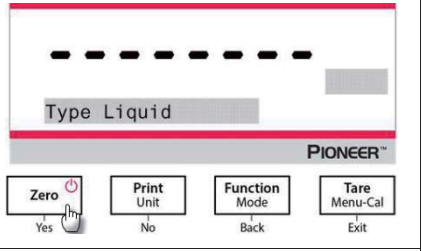

After setting the volume, press **Yes** to begin the weighing.
Note: when the Density Type is set to Liquid, the Liquid type and Porous material selections are disabled.

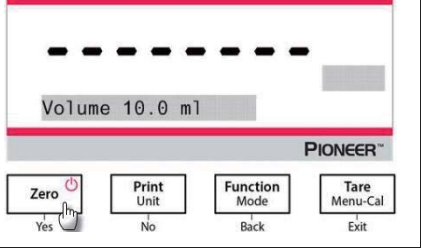

1. Weigh the calibrated sinker in the air with the balance and the density determination kit.
 When the * (symbol of stability) appears, press the **Function / Mode** button to confirm the weight of the calibrated sinker in the air.

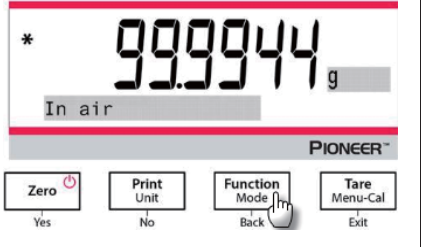

2. Weigh the calibrated sinker submerged in the liquid with the balance and the density determination kit. Lower the calibrated sinker down into the liquid until it is fully submerged (1 cm below the surface of the liquid).
3. When the * (symbol of stability) appears, press the **Function / Mode** button to confirm the weight of the calibrated sinker. The density of the liquid is displayed.

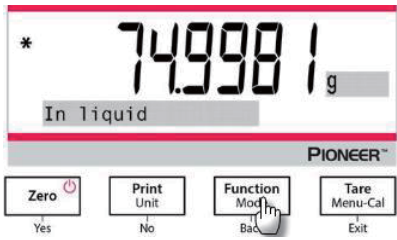

4. After completion of the test, press the **Function / Mode** button to test a new sample.

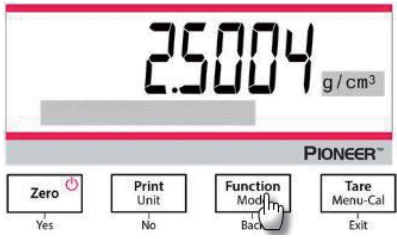

4.5.5 Measuring the Density of Porous Material Using Oil

Press and hold the **Function / Mode** button until *Density* appears. Press **Yes** to enter the *Density Determination*.

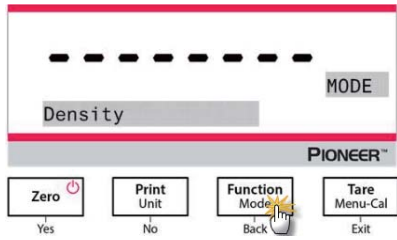

Item Settings:

- Sample type: Solid
- Auxiliary Liquid: Water
- Porous Material: On

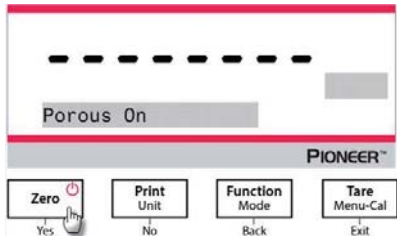

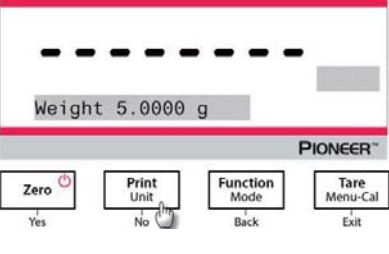
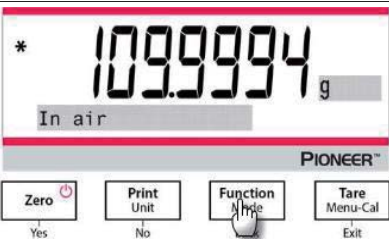
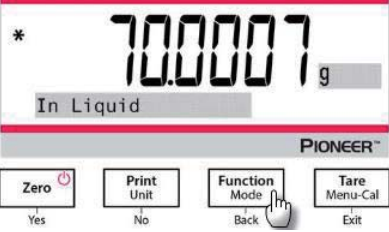
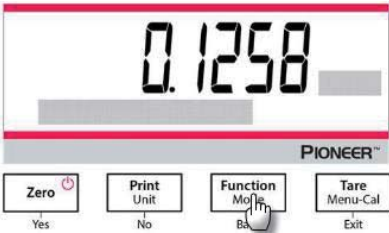
<p>Set the following parameters by pressing No or Back:</p> <ul style="list-style-type: none"> • Water Temperature • Weight • Oil Density <p>Measure the actual water temperature using a precision thermometer. The balance calculates water density based on the water temperature value entered.</p> <p>Note: The weight of the sample and the density of oil must be measured in advance.</p>	
<ol style="list-style-type: none"> 1. Weigh the oiled sample in the air with the balance and the density determination kit. 2. When the * (symbol of stability) appears, press the Function / Mode button to confirm the weight of the oiled sample in the air. 	
<ol style="list-style-type: none"> 3. Weigh the oiled sample in the liquid with the balance and the density determination kit. 4. When the * (symbol of stability) appears, press the Function / Mode button to confirm the weight of the oiled sample in the liquid. The density of the sample is displayed. 	
<ol style="list-style-type: none"> 5. After completion of the test, press the Function / Mode button to test a new sample. 	

4.6 Additional Features

Weigh Below

Note: Ensure the balance has been leveled and calibrated.

The PX balance is equipped with a weigh below hook for weighing below the balance (as shown in the figure below).

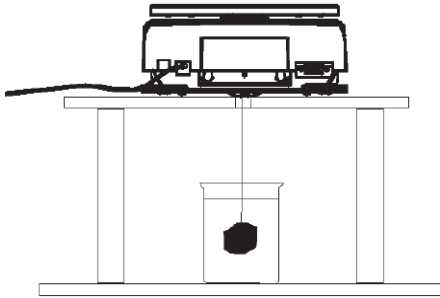

Before turning the balance over, remove the pan and draft shield elements (if present) to prevent damage. Do not place the balance on the pan support cone or load cell pins.

To use this feature, remove power from the balance, then remove the protective cover for the weigh below opening.

Power on the balance, and then use a string or wire to attach items to be weighed.

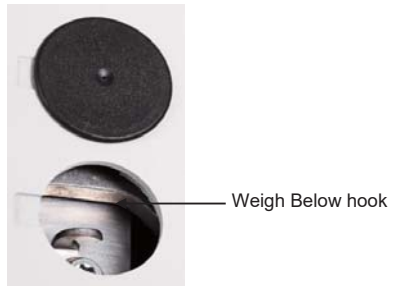
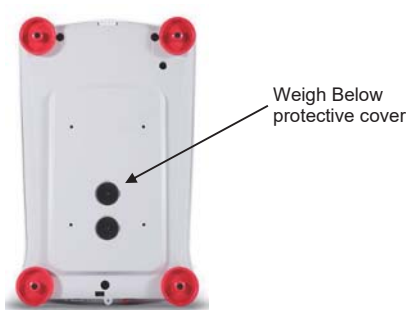

5. MENU SETTINGS

5.1 Menu Navigation

TABLE 5-1. USER MENU STRUCTURE

Calibration	Setup	Units	RS232	Print	GLP	Factory Reset	Lockout
Internal Cal	Language	Gram	Baud Rate	Stable Only	Header 1	Reset All	Calibration
Automatic Cal	Filter Level	Kilogram	Transmission	Numeric Only	Header 2		Setup
Span Cal	AZT	Milligram	Handshake	Single Header	Header 3		Units
Linearity Cal	Auto Tare	Carat		Print To	Header 4		RS232
InCal Adjust	Graduations	Newton		Auto Print	Header 5		Print
	Date format	Pound		Header	Balance Name		GLP
	Date	Ounce		Date and Time	User Name		Factory Reset
	Time Format	Ounce Troy		Balance ID	Project Name		
	Time	Grain		Balance Name			
	Brightness	Pennyweight		User Name			
	Auto Dim	Momme		Project Name			
	Capacity Bar	Mesghal		Application Name			
	Approved Mode	Hong Kong Tael		Result			
		Singapore Tael		Gross			
		Tanwan Tael		Net			
		Tical		Tare			
		Tola		Signature Line			
		Baht		Line Feed			
		Custom unit					

Note: PX balances are classified into InCal models and ExCal models.

5.1.1 Changing Settings

To change a menu setting, navigate to that setting using the following steps:

Enter the Menu

Long press the Menu button to enter the **Menu**.

Select the Sub-Menu

Press **No** to step between the sub-menus, and press **Yes** to enter the sub-menu.

Select the Menu Item

Press **No** to step through the Menu Items, and press **Yes** to enter the displayed Menu Item.

5.2 Calibration

PX balances offer a choice of three calibration methods: Internal Calibration (for InCal models only), Span calibration and Linearity Calibration.

Attention: Do not disturb the balance during any calibration.

5.2.1 Calibration Sub-menu (InCal models)

Note: ExCal models only have Span Calibration and Linearity Calibration.

5.2.2 Internal Calibration (not applicable to ExCal models)

Calibration is accomplished with the internal calibration mass. Internal Calibration can be performed at any time, provided the balance has warmed up to operating temperature and is level.

With the Balance turned ON and no load on the pan, the internal calibration can be performed.

Alternatively, press the **Tare / Menu-Cal** button and select *Internal Cal* to initiate the internal calibration.

The screen shows the status, and then press any button to return to the current application after calibration.

5.2.3 Automatic Calibration (PX85 PX125D PX225D ONLY)

When **Automatic Calibration** is set ON, the balance performs a self calibration:

- when it senses a temperature change of 1.5°C
- or every 3 hours

AutoCal will automatically calibrate the Balance (using the internal mass) each time there is a change in temperature significant enough to affect accuracy.

5.2.4 InCal Adjust (not applicable to ExCal models)

Use this calibration method to fine tune the effect of the Internal Calibration.

Calibration Adjust may be used to adjust the result of the Internal Calibration by ± 100 divisions.

Note: Before making a calibration adjustment, perform an Internal Calibration. To verify whether an adjustment is needed, place a test mass equal to the **span calibration value** on the pan and note the difference (in divisions) between the nominal mass value and the actual balance reading. If the difference is within +/- division, calibration adjustment is not required. If the difference exceeds +/-1 division, calibration adjustment is recommended.

Example:

Expected weight reading:	200.000 (Test mass value)
Actual weight reading:	200.014
Difference in gram:	- 0.014
Difference in division:	- 14 (InCal Adjust value)

To perform a Calibration Adjustment, select InCal Adjustment from the list of Calibration Menu; enter the value (positive or negative divisions) to match the difference noted earlier in the procedure.

Recalibrate using Internal Calibration. After calibration, place the test mass on the pan and verify that the mass value now matches the displayed value. If not, repeat the procedure until Internal Calibration reading agrees with the test mass.

Once completed, the balance stores the Adjustment value and the display returns to the current application.

5.2.5 Span Calibration

Span calibration uses two calibration points, one at zero load and the other at specified full load (span). For detailed calibration mass information, please see the specification tables in section 9.1.

With the balance turned ON and no load on the pan, Span Calibration can be performed. The best accuracy is achieved using the mass closest to the full span value.

Steps for span calibration

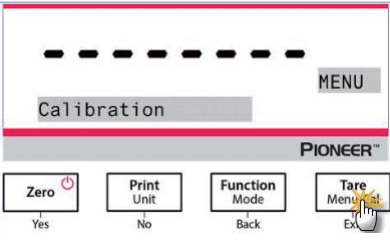
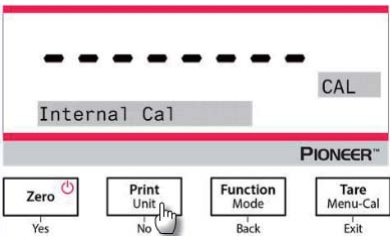
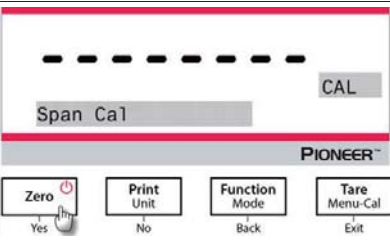
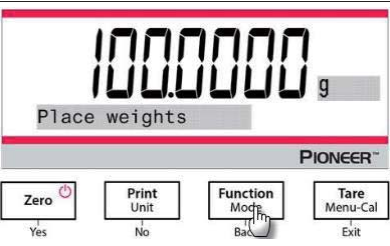
<p>1. Press and hold the Tare / Menu-Cal button, and the Calibration Menu will display.</p>	
<p>2. Press Yes to enter the Calibration Menu. To change the calibration mode, press No until Span Cal (span calibration) is displayed.</p>	
<p>3. Press Yes to begin the span calibration.</p>	
<p>4. The calibration masses value will be shown in the screen. After the display shows "Place weights" and "100.000 g", place weight(s) of 100 g on the pan for calibration. To change to the calibration point of half full capacity (e.g. 50 g), press the Function / Mode button. After the screen shows "Place weights" and "50.000 g", place weight(s) of 50 g on the pan for calibration.</p>	

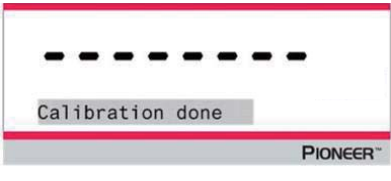
<p>5. Remove the weight from the pan.</p>	 <p>The display shows '0.0000 g' at the top. Below it is a grey bar with the text 'Remove weights'. At the bottom right is the 'PIONEER™' logo.</p>
<p>6. Once the span calibration is completed successfully, "Calibration done" will display. Press any button to return to the previous screen.</p>	 <p>The display shows a dashed line '-----' at the top. Below it is a grey bar with the text 'Calibration done'. At the bottom right is the 'PIONEER™' logo.</p>

5.2.6 Linearity Calibration

Linearity calibration uses three calibration points, one at zero load and the others at specified loads.

For detailed calibration mass information, please see the specification tables in section 9.1.



With no load on the scale, Linearity Calibration can be performed.

The balance captures the zero point, and then prompts for the next weight.

Continue to follow the instructions on the display until the calibration is completed.

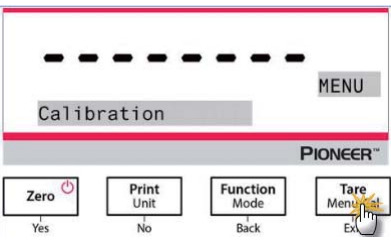
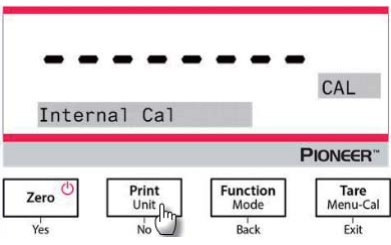
Steps for linearity calibration

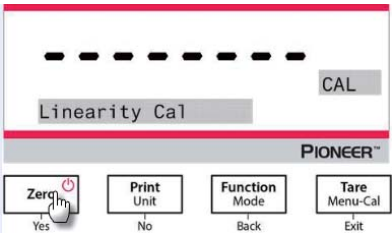
<p>1. Press and hold the Tare / Menu-Cal button, and the Calibration Menu will display.</p>	 <p>The display shows a dashed line '-----' at the top. Below it is a grey bar with the text 'Calibration'. To the right is a 'MENU' button. At the bottom right is the 'PIONEER™' logo. Below the display are four buttons: 'Zero' (Yes), 'Print Unit' (No), 'Function Mode' (Back), and 'Tare Menu-Cal' (Exit). A mouse cursor is pointing at the 'Tare Menu-Cal' button.</p>
<p>2. Press Yes to enter the Calibration Menu. To change the calibration mode, press No until Linearity Cal (linearity calibration) is displayed.</p>	 <p>The display shows a dashed line '-----' at the top. Below it is a grey bar with the text 'Internal Cal'. To the right is a 'CAL' button. At the bottom right is the 'PIONEER™' logo. Below the display are four buttons: 'Zero' (Yes), 'Print Unit' (No), 'Function Mode' (Back), and 'Tare Menu-Cal' (Exit). A mouse cursor is pointing at the 'Print Unit' button.</p>

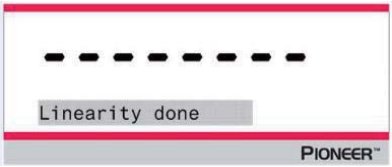
<p>3. Press Yes to begin the linearity calibration.</p>	
<p>4. Calibration masses value will be shown in the screen. After the display shows "Place weights" and "50.0000 g", place weight(s) of 50 g on the pan for calibration.</p>	
<p>5. Remove the weight(s) of 50 g from the pan. After a while, "100.0000 g" will be displayed on the screen. Please place weight(s) of 100 g on the pan for calibration.</p>	
<p>6. Once the linearity calibration is completed successfully, "Linearity done" will display. Press any button to return to the previous screen.</p>	

5.3 Balance Setup

Enter this sub-menu to customize balance functionality.

Note: The factory default settings are shown below in bold.

5.3.1 Language

Set the language displayed for menus and displayed messages.

- English**
- Deutsch
- Français
- Italiano
- Polski
- Español
- Türkçe
- 한국
- 中文
- 日本語

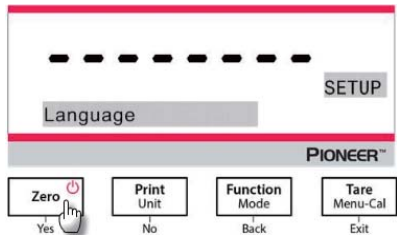

5.3.2 Filter Level

Set the amount of signal filtering.

- Low = faster stabilization time with less stability.
- Medium = normal stabilization time with normal stability.**
- High = slower stabilization time with more stability.

5.3.3 AZT (Auto Zero Tracking)

Set the automatic zero tracking functionality.

- Off = disabled.
- 0.5 d = display maintains zero up to a drift of 0.5 graduation per second.
- 1 d = display maintains zero up to a drift of 1 graduation per second.**
- 3 d = display maintains zero up to a drift of 3 graduations per second.**

5.3.4 Auto Tare

Set the automatic tare.

- Off = disabled.
- On = enabled.

Note: "Place container" will be displayed when Automatic Tare is set to On.

5.3.5 Graduations

Set the displayed readability of the balance.

- 1 Division = standard readability.**
- 10 Divisions = readability is increased by a factor of 10.

For example, if the standard readability is 0.01g, selecting 10 Divisions will result in a displayed reading of 0.1 g.

5.3.6 Date Format

Set the current date format.

- YYYY/MM/DD
- MM/DD/YYYY**
- DD/MM/YYYY

5.3.7 Date Setup

Set the date in the current date format.

For example, if the date format is MM/DD/YYYY, the date could be set as "06/22/2017 Thu".

5.3.8 Time Format

Set the current time format.

- 24HR**
- 12HR

5.3.9 Time Setup

Set the time in the current time format.

For example, if the time format is 24HR, the time could be set as 08:00:00.

5.3.10 Brightness

Set the brightness of the display.

Low
Medium
High

5.3.11 Auto Dim

Set whether the balance automatically turns off the display backlight of the display.

Off = disabled

10 minutes = become dim if there is no motion for 10 minutes

20 minutes = become dim if there is no motion for 20 minutes

30 minutes = become dim if there is no motion for 30 minutes

5.3.12 Capacity Bar

Off = disabled

On = enabled

When the capacity is set On, a capacity bar will display at the bottom of the screen. The capacity bar will roughly show the current weight as a percentage of balance capacity. When the display is at zero, the capacity bar will not display.

5.3.13 Approved Mode

Use this menu to set the Legal for Trade status.

Off = standard operation.

On = operation complies with Legal Metrology regulations.

Note: When Approved Mode is set to On, the menu settings are affected as follows:

Calibration Menu:

- For InCal models, only Internal Calibration is available. All other functions are hidden.

Balance Setup Menu:

- Filter Level is locked at the current setting.
- Auto Zero Tracking is limited to 0.5 Division and Off. The selected setting is locked.
- Auto Tare is locked at current setting.
- Graduations are forced to 1 Division and the menu item is hidden.

Communication Menu (Communication->Print Settings->Print Output):

- Stable Weight Only is locked On.
- Numeric Value Only is locked Off.

Communication Menu (Communication->Print Settings->Auto Print):

- Auto print mode selections are limited to Off, On Stability, and Interval. Continuous is not available.

Lockout Menu:

- Menu is hidden

Note: The security switch located at the rear of the balance must be in the locked position to set Approved Mode to On. The security switch must be in the unlocked position to set Approved Mode to Off. See Section 6.

5.4 Weighing Units

Enter this sub-menu to activate the desired units of measure.

PX balances provide a choice of 19 units, which are all set On by default.

Note: Due to national laws, the balance may not include some of the units of measure listed.

Display	Unit
g	Gram
kg	Kilogram
mg	Milligram
ct	Carat
N	Newton
lb	Pound
oz	Ounce
ozt	Troy ounce
GN	Grain

Display	Unit
dwt	Pennyweight
mo	Momme
msg	Mesghal
tl H	HK tael
tl S	SG tael
tl T	TW tael
tcl	Tical
tola	Tola
baht	Baht
C1	Custom unit

Changing Weighing Units

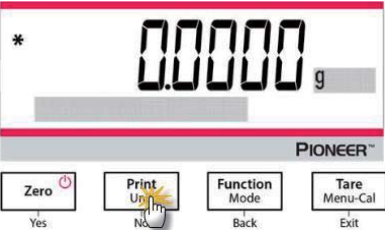
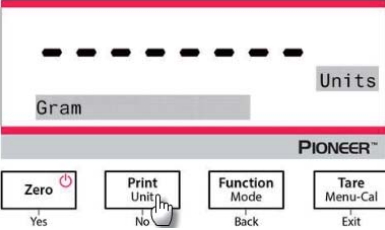
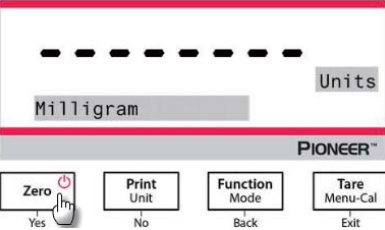
<p>1. Press and hold the Print / Unit button until the <i>Unit Menu</i> is displayed.</p>	 <p>The screenshot shows the balance display with '0.0000 g' and a '*' symbol. Below the display are four buttons: 'Zero' (Yes), 'Print Unit' (No), 'Function Mode' (Back), and 'Tare Menu-Cal' (Exit). A hand icon is shown pressing the 'Print Unit' button.</p>
<p>2. The default unit is gram (g). To change the unit, press No to advance to the next unit.</p>	 <p>The screenshot shows the 'Unit Menu' with 'Gram' displayed and 'Units' on the right. The 'Print Unit' button is being pressed, and the 'No' option is highlighted.</p>
<p>3. Press Yes to set the unit displayed to the weighing unit.</p>	 <p>The screenshot shows the 'Unit Menu' with 'Milligram' displayed and 'Units' on the right. The 'Zero' button is being pressed, and the 'Yes' option is highlighted.</p>

Defining Custom Unit

Set Custom to On in the Unit menu to enable and define the Custom Unit.

The Custom Unit is defined by entering three parameters, Factor, Exponent and LSD (least significant digit).

Define the Custom Unit as follows:

1. Determine how many custom units there are in 1 gram.
2. Convert the value to scientific notation, e.g. $m \times 10^n$.
3. Enter the value of m as the Factor setting.
4. Enter the value of n as the Exponent setting.
5. Enter the amount that the Custom Unit steps by as the LSD setting.

Enter the Factor and the Exponent and LSD.

Factor	Exponent (+3 to -3)	Conversion Factor
.1234	3	123.4
.1234	2	12.34
.1234	1	1.234
.1234	0	.1234
.1234	-1	.01234
.1234	-2	.001234
.1234	-3	.0001234

Custom Unit = Conversion Factor x Grams.

The LSD is the value by which the displayed weight is incremented or decremented.

LSD	Result
.5	Adds one decimal place Display counts by 5
1	Display counts by 1
2	Display counts by 2
5	Display counts by 5
10	Display counts by 10
100	Display counts by 100

Note:

The conversion factor is used by the balance to convert grams to the custom weighing unit and is defined by entering a factor and an exponent. The factor is a value between 0.1000000 and 1.999999 inclusive.

For example: One cup of chemical = 0.5643834×1 g, the factor should be set 0.5643834.

The exponent moves the decimal point of the factor to the right for positive values or to the left for negative values.

For example: One cup of chemical = 10 g, the exponent should be set 2.

The LSD is the value by which weight is incremented or decremented.

LSD	Result
1	Display counts by 1
5	Display counts by 5
10	Display counts by 10
...	...

For example, if the displayed digital is 0.56 for one cup of chemical, the LSD should be set 100.

5.5 RS232 Interface Setup

Enter this sub-menu to customize RS232 standard settings. Data may be output to either a printer or a PC.

5.5.1 Baud Rate

Set the baud rate (bits per second).

1200	= 1200 bps
2400	= 2400 bps
4800	= 4800 bps
9600	= 9600 bps
19200	= 19200 bps
38400	= 38400 bps

5.5.2 Transmission

Set the data bits, stop bit, and parity.

8-NO-1	= 8 data bits, no parity, stop bit 1
8-NO-2	= 8 data bits, no parity, stop bit 2
7-EVEN-1	= 7 data bits, even parity, stop bit 1
7-EVEN-2	= 7 data bits, even parity, stop bit 2
7-NO-1	= 7 data bits, no parity, stop bit 1
7-NO-2	= 7 data bits, no parity, stop bit 2
7-ODD-1	= 7 data bits, odd parity, stop bit 1
7-ODD-2	= 7 data bits, odd parity, stop bit 2

5.5.3 Handshake

Set the flow control method.

None	= no handshaking
Xon-Xoff	= XON/XOFF handshaking
Hardware	= hardware handshaking

5.6 Print Settings

Enter this sub-menu to customize data transfer settings.

5.6.1 Stable Only

Off = values are printed immediately, regardless of stability.
On = values are printed only when the stability criteria are met.

5.6.2 Numeric Only

Off = All selected results are printed.
On = Only numeric data values are printed.

5.6.3 Single Header

Off = Headers will be printed for every print requirement.
On = Headers will be printed once a day.

5.6.4 Print To

PC = print data to a PC
Printer = print data to a printer

5.6.5 Auto Print

Off = disabled

On Stability¹ = printing occurs each time the stability criteria are met.

Print Interval² = printing occurs at the defined time interval.

Continuous = printing occurs continuously.

¹When On Stability is selected, set the conditions for printing.

Load = Prints when the displayed load is stable.

Load and Zero = Prints when the displayed load and zero readings are stable.

²When Print Interval is selected, set the time interval using the numeric keypad.

Settings of 1 to 3600 seconds are available. Default is 0.

5.6.6 Header

On = the header is printed.

Off = the header is not printed.

5.6.7 Date and Time

On = the date and the time are printed.

Off = neither the date nor the time is printed.

5.6.8 Balance ID

On = the balance ID is printed.

Off = the balance ID is not printed.

5.6.9 Balance Name

On = the balance name is printed.

Off = the balance name is not printed.

5.6.10 User Name

On = the user name is printed.

Off = the user name is not printed.

5.6.11 Project Name

On = the project name is printed.

Off = the project name is not printed.

5.6.12 Application Name

On = the application name is printed.

Off = the application name is not printed.

5.6.13 Result

On = the weighing result is printed.

Off = the weighing result is not printed.

5.6.14 Gross

On = the gross weight is printed.

Off = the gross weight is not printed.

5.6.15 Net

On = the net weight is printed.

Off = the net weight is not printed.

5.6.16 Tare

On = the tare weight is printed.

Off = the tare weight is not printed.

5.6.17 Line Feed

1 Line = move the paper up one line after printing.

4 Lines = move the paper up four lines after printing.

5.6.18 Signature Line

On = the Signature Line is printed.

Off = the Signature Line is not printed.

5.7 GLP

Enter this menu to set the Good Laboratory Practices (GLP).

5.7.1 Header

Enables the printing of GLP headings. There are up to 5 headings available.

Alphanumeric settings up to 25 characters are available for each Header setting

5.7.2 Balance Name

Set the balance name.

Alphanumeric settings up to 16 characters are available.

5.7.3 User Name

Set the user name.

Alphanumeric settings up to 16 characters are available. The default is blank.

5.7.4 Project Name

Set the project name.

Alphanumeric settings up to 16 characters are available. The default is blank.

5.8 Factory Reset

Use this sub-menu to reset the all menu settings to their Factory default settings.

Reset All = resets all menus to their factory default settings.

Exit = return to application main screen without resetting any menus.

5.9 Lockout

Use this sub-menu to lock/unlock certain menus.

Off = the menu is unlocked

On = the menu is locked

6. LEGAL FOR TRADE (LFT)

When the balance is used in trade or a legally controlled application it must be set up, verified and sealed in accordance with local weights and measures regulations. It is the responsibility of the purchaser to ensure that all pertinent legal requirements are met.

6.1 Settings

Before the verification and sealing perform the following steps:

1. Verify the menu settings meet the local weights and measures regulations.
2. Perform a calibration as explained in Section 5.
3. Set the position of the security switch as shown in Section 6.3.

Note: When the security switch is set on the following menu settings cannot be changed: calibration, setup, mode, unit and lockout. For more details, see Section 5.3.13.

6.2 Verification

The local weights and measures official or authorized service agent must perform the verification procedure.

6.3 Securing the Menu

A slide switch is used to secure the Lock menu settings. When the switch is set to the On position, the Lock menu settings may be viewed but not changed. This switch is located behind the Base.

Set the position of the switch to ON by sliding the external Lock Switch to LOCKED as shown in the figure below.



Note: This switch is also used in conjunction with the Legal for Trade menu item. When the Legal for Trade menu is set to ON, the switch must be set to the On position to prevent calibration and changes to metrologically significant settings.

6.4 Sealing Access to the Balance Settings

The local weights and measures official or authorized service agent must apply a security seal to prevent tampering with the settings. Refer to the illustrations below for the sealing methods.



Un-locked



Locked with Paper Seal



Locked with Wire Seal

7. Printing

7.1 Connecting, Configuring and Testing the Printer / Computer Interface

Use the built-in RS-232 Port to connect either to a computer or a printer.

If connecting to a computer, use HyperTerminal or similar software like SPDC described below.

(Find HyperTerminal under **Accessories/Communications** in Windows XP.)

Connect to the computer with a standard (straight-through) serial cable.

Choose **New Connection**, "connect using" COM1 (or available COM port).

Select **Baud=9600; Parity=8 None; Stop=1; Handshaking=None**. Click **OK**.

Choose Properties/Settings, then ASCII Setup. Check boxes as illustrated:

(Send line ends...; Echo typed characters...; Wrap lines...)

Use RS232 Interface Commands (Section 9.6.1) to control the balance from a PC.

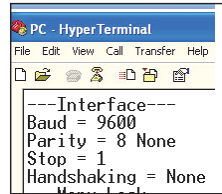

SPDC Software

The Serial Port Data Collection / SPDC software is provided by Ohaus and can be used on operating systems that do not have the HyperTerminal software mentioned above. SPDC software can preliminarily collect and transfer the data to Microsoft files (such as Excel, Word, etc.).

Choose the export file type and export file path and then press Run as shown below.

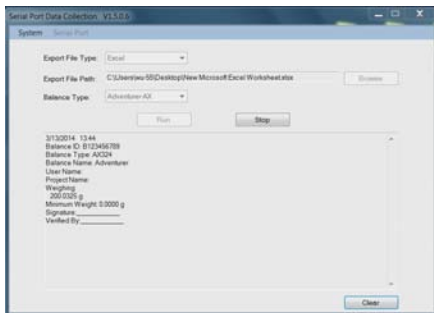

Note: The latest SPDC software support English and Chinese language and can be downloaded from the Ohaus' website. For more information, refer to the *SPDC Data Collection Instruction Manual*.

7.2 Output Format

The Result Data, and G/N/T data, is output in the following format.

Field:	Label ¹	Space ²	Weight ³	Space ²	Unit ⁴	Space	Stability ⁵	Space	G/N ⁶	Space	Term. Characters ⁷
Length:		1	11	1	5	1	≤ 1	≤ 1	≤ 3	0	≤ 8

Note:

1. The length of the label field is not fixed.
2. Each field is followed by a single delimiting space (ASCII 32).
3. The Weight field is 11 right justified characters. If the value is negative, the '-' character is located at the immediate left of the most significant digit.
4. The Unit field contains the unit of measure abbreviation up to 5 characters, right justified.
5. The Stability field contains the "?" character if the weight reading is not stable. The Stability field and the following Space field are omitted if the weight reading is stable.
6. The G/N field contains the net or gross indication. For net weights, the field contains "N". For gross weights, the field contains "G".
7. The Termination Characters field contains CRLF, Four CRLF or Form Feed (ASCII 12), depending on the LINE FEED menu setting.
8. When Numeric Only is set On, only the Weight Field is printed, left-aligned.

7.3 Printout Examples

Examples for each Application are shown with all items turned **ON** in the **Print** menu. The default values for **Header** lines 1-5 are also shown.

BASIC WEIGHING

```
Header 1
Header 2
Header 3
Header 4
Header 5
07/19/2017 17:56:23
Balance ID: B234567890
Balance Name: PX5202
User Name:
Project Name:
Weighing
49.98 g
Gross: 49.98 g G
Net: 49.98 g N
Tare: 0.00 g T

Signature: _____
Verified By: _____
```

PART COUNTING

```
Header 1
Header 2
Header 3
Header 4
Header 5
07/19/2017 17:57:19
Balance ID: B234567890
Balance Name: PX5202
User Name:
Project Name:
Parts Counting
Quantity: 4999 PCS
Gross: 49.99 g G
Net: 49.99 g N
Tare: 0.00 g T
APW: 0.010 g
Sample Size: 10 PCS

Signature: _____
Verified By: _____
```

PERCENT WEIGHING

```
Header 1
Header 2
Header 3
Header 4
Header 5
07/19/2017 17:57:19
Balance ID: B234567890
Balance Name: PX223/E
User Name:
Project Name:
Percent Weighing
Percentage: 10.156 % N
Gross: 23.361 g G
Net: 10.156 g N
Tare: 13.205 g T
Reference weight: 100.000 g

Signature: _____
Verified By: _____
```

DYNAMIC WEIGHING

Header 1
Header 2
Header 3
Header 4
Header 5
07/19/2017 18:00:12
Balance ID: B234567890
Balance Name: PX5202
User Name:
Project Name:
Dynamic Weighing
Final weight: 49.99 g
Gross: 50.06 g G
Net: 50.06 g N
Tare: 0.00 g T
Averaging Time: 10 s

Signature: _____
Verified By: _____

DENSITY

(Density Type=Solid, auxiliary liquid=water,porous material=on)

Header 1
Header 2
Header 3
Header 4
Header 5
07/19/2017 18:03:23
Balance ID: B234567890
Balance Name: PX5202
User Name:
Project Name:
Density
Density: 0.0345 g/cm³
Gross: 49.99 g G
Net: 49.99 g N
Tare: 0.00 g T
Oiled Weight: 199.89 g
Weight in liquid: 49.98 g
Auxiliary liquid: Water
liquid density: 0.9982 g/cm³
Temp.: 20.0 °C
Porous: On
Oil density: 0.8000 g/cm³
Dry Weight: 5.00 g

Signature: _____
Verified By: _____

DENSITY

(Density Type=liquid, sinker volume=10ml)

Header 1
Header 2
Header 3
Header 4
Header 5
07/19/2017 18:05:17
Balance ID: B234567890
Balance Name: PX5202
User Name:
Project Name:
Density
Density: 14.9820 g/cm³
Gross: 49.98 g G
Net: 49.98 g N
Tare: 0.00 g T
Weight in air: 199.88 g
Weight in liquid: 50.05 g
Sinker Volume: 10.0 ml

Signature: _____
Verified By: _____

INTERNAL CALIBRATION

-OHAUS-
07/26/2017 05:16:53
Balance ID:
Balance Name: PX2202
User Name:
Project Name:
---Internal Calibration---
Calibration is done.
Difference weight: 0.00 g

Signature: _____
Verified By: _____

SPAN CALIBRATION

-OHAUS-
03/19/2000 04:51:46
Balance ID:
Balance Name: PX2202ZH/E
User Name:
Project Name:
---Span Calibration---
Calibration is done.
Reference weight: 2000.00 g
Actual weight: 2000.22 g
Difference weight: 0.22 g
Weight ID: _____

Signature: _____
Verified By: _____

LINEARITY CALIBRATION

-OHAUS-
01/01/2000 17:30:47
Balance ID:
Balance Name: PX5202M
User Name:
Project Name:
---Linearity Calibration---
Calibration is done.

Signature: _____
Verified By: _____

8.MAINTENANCE

8.1 Calibration

Periodically verify calibration by placing an accurate weight on the balance and viewing the result. If calibration is required, refer to section 5.2 for instructions.

8.2 Cleaning



WARNING: Disconnect the balance from the power supply before cleaning. Make sure that no liquid enters the interior of the balance.

Clean the balance at regular intervals.

Housing surfaces may be cleaned with a lint-free cloth slightly dampened with water or a mild cleaning agent.



Glass surfaces may be cleaned with a commercial glass cleaner.

Attention: Do not use solvents, harsh chemicals, ammonia or abrasive cleaning agents.

8.3 Troubleshooting

TABLE 8-1. TROUBLESHOOTING

Symptom / Display	Possible Cause	Remedy
Balance will not turn on	No power to the balance	Verify connection and voltage
Poor accuracy	Improper calibration Unstable environment	Perform calibration Move balance to suitable location
Cannot calibrate	Calibration Menu locked Approved Mode set to on Unstable environment Incorrect calibration masses	Turn Calibration menu lock off Turn Approved Mode off Move balance to suitable location Use correct calibration masses
Cannot change menu settings	Sub-menu locked Approved Mode set to on	Unlock sub-menu Turn Approved Mode off
Low Reference weight	Reference weight too small The weight on the pan is too small to define a valid reference weight.	Increase sample size
Invalid Piece Weight	Average piece weight is too small	Increase average piece weight
Operation Timeout	Weight reading is not stable	Move balance to suitable location
Err 8.3	Weight reading exceeds overload limit.	Remove weight from the pan
Err 8.4	Weight reading below underload limit.	Re-install the pan
-----	Busy (tare, zero, printing, waiting for a stable weight)	Wait until completion

8.4 Service Information

If the troubleshooting section does not resolve your problem, contact an Authorized Ohaus Service Agent. Please visit our website www.ohaus.com to locate the Ohaus office nearest you.

9. TECHNICAL DATA

9.1 Specifications

Ambient conditions

- Indoor use only
- Altitude: Up to 2000 m
- Specified Temperature range: 10°C to 30°C
- Humidity: maximum relative humidity 80% for temperatures up to 30°C, decreasing linearly to 50% relative humidity at 40°C
- Operability is assured at ambient temperatures between 5°C and 40°C
- Mains supply voltage fluctuations: up to $\pm 10\%$ of the nominal voltage
- Installation category II
- Pollution degree: 2
- Supply voltage: 12V=0.5A

Materials

- Bottom Housing: Die-cast Aluminum, Painted
- Top Housing: Plastic (HIPS)
- Weighing Platforms: Stainless steel
- Draft Shield: Glass, plastic (HIPS)
- Feet: Plastic (ABS)

TABLE 9-1. SPECIFICATIONS

InCal Model	PX85	PX125D	PX225D	PX84	PX124	PX224	PX163
ExCal Model				PX84/E	PX124/E	PX224/E	PX163/E
Capacity (g)	82	52/120	82/220	82	120	220	160
Readability d (g)	0.00001	0.00001/ 0.0001	0.00001/ 0.0001	0.0001	0.0001	0.0001	0.001
Repeatability (STDEV) (g)	0.00002	0.00002/ 0.0001	0.00002/ 0.0001	0.0001	0.0001	0.0001	0.001
Linearity (g)	±0.0001	±0.0001	±0.0001	±0.0002	±0.0002	±0.0002	±0.002
Stabilization Time Typical (s)	10	10	10	3	3	3	2
Sensitivity Temperature Drift (PPM/K)	±0.8	±0.8	±0.8	±3	±3	±3	±8
Typical Minimum Weight USP (USP K=2,U=0.10%)	20 mg	20 mg	20 mg	200 mg	200 mg	200 mg	2 g
Optimized Min-Weight (g) (USP, u=0.10%, k=2) SRP≤0.41d*	9 mg	9 mg	9 mg	82 mg	82 mg	82 mg	0.82 g
Units	Gram, Milligram, Carat, Ounce, Ounce Troy, Grain, Pennyweight, Momme, Mesghal, Tical (MM), Tola (India), Baht, 1 Custom unit			Gram, Milligram, Carat, Newton, Ounce, Ounce Troy, Grain, Pennyweight, Momme, Hong Kong Tael, Singapore Tael, Taiwan Tael, Tical (MM), Tola (India), 1 Custom unit, Kilogram, Pound, Baht			
Applications	Basic Weighing, Parts Counting, Percent Weighing, Dynamic Weighing, Density Determination						
Platform Size (diameter, mm)	80	80	80	90	90	90	120
Span Calibration Points (g)	50, 80	50, 100	100, 200	50, 80	50, 100	100, 200	100, 150, 160
Linearity Calibration Points (g)	0, 40, 80	0, 50, 100	0, 100, 200	0, 40, 80	0, 50, 100	0, 100, 200	0, 80, 160
Tare Range	To capacity by subtraction						
Power Supply	Power input: 100-240V ~ 200mA 50-60Hz 12-18VA Power output: 12 VDC 0.5A						
Assembled Dimensions (W x D x H) (mm)	209 x 321 x 309						
Communication	RS232, USB						
Operating Temperature Range	Operating conditions for ordinary lab application: +10°C to 30°C (operability guaranteed between +5°C and 40°C).						
Storage Temperature Range	Humidity: maximum relative humidity 80 % for temperatures up to 30°C, decreasing linearly to 50% relative humidity at 40°C						
Storage Conditions	-10°C to 60°C, humidity 10% to 90%, without condensation						
Net Weight	10 lb / 4.5 kg						
Shipping Weight	15.4 lb / 7 kg						
Shipping Dimensions (W x D x H) (mm)	507 x 387 x 531						

Note:

*SRP refers to the standard deviation for n replicate weightings (n ≥ 10).

TABLE 9-2. SPECIFICATIONS (continued)

InCal Model	PX223	PX323	PX423	PX523	PX623	PX822	PX1602	PX2202
ExCal Model	PX223/E	PX323/E	PX423/E	PX523/E	PX623/E	PX822/E	PX1602/E	PX2202/E
Capacity (g)	220	320	420	520	620	820	1600	2200
Readability d (g)	0.001	0.001	0.001	0.001	0.001	0.01	0.01	0.01
Repeatability (STDEV) (g)	0.001	0.001	0.001	0.001	0.001	0.01	0.01	0.01
Linearity (g)	±0.002	±0.002	±0.002	±0.002	±0.002	±0.02	±0.02	±0.02
Stabilization Time Typical (s)	2	2	2	2	2	1	1	1
Sensitivity Temperature Drift (PPM/K)	±9	±3	±3	±3	±3	±6	±6	±6
Typical Minimum Weight USP (USP K=2,U=0.10%)	2 g	2 g	2 g	2 g	2 g	20 g	20 g	20 g
Optimized Min-Weight (g) (USP, u=0.10%, k=2) SRP≤0.41d*	0.82 g	0.82 g	0.82 g	0.82 g	0.82 g	8.2 g	8.2 g	8.2 g
Units	Gram, Milligram, Carat, Newton, Ounce, Ounce Troy, Grain, Pennyweight, Momme, Hong Kong Tael, Singapore Tael, Taiwan Tael, Tical (MM), Tola (India), 1 Custom unit, Kilogram, Pound, Baht					Gram, Kilogram, Carat, Newton, Pound, Ounce, Ounce Troy, Grain, Pennyweight, Momme, Mesghal, Hong Kong Tael, Singapore Tael, Taiwan Tael, Tical (MM), Tola (India), Baht, 1 Custom unit		
Applications	Basic Weighing, Parts Counting, Percent Weighing, Dynamic Weighing, Density Determination							
Platform Size (diameter, mm)	120	120	120	120	120	180	180	180
Span Calibration Points (g)	100, 200	200, 300	200, 400	300, 500	300, 500, 600	500, 800	1000, 1500, 1600	1000, 2000
Linearity Calibration Points (g)	0, 100, 200	0, 150, 300	0, 200, 400	0, 250, 500	0, 300, 600	0, 400, 800	0, 800, 1600	0, 1000, 2000
Tare Range	To capacity by subtraction							
Power Supply	Power input: 100-240V ~ 200mA 50-60Hz 12-18VA Power output: 12 VDC 0.5A							
Assembled Dimensions (W x D x H) (mm)	209 x 321 x 309					209 x 321 x 98		
Communication	RS232, USB							
Operating Temperature Range	Operating conditions for ordinary lab application: +10°C to 30°C (operability guaranteed between +5°C and 40°C).							
Storage Temperature Range	Humidity: maximum relative humidity 80% for temperatures up to 30°C, decreasing linearly to 50% relative humidity at 40°C							
Storage Conditions	-10°C to 60°C, humidity 10% to 90%, without condensation							
Net Weight	10 lb / 4.5 kg					7.7 lb / 3.5 kg		
Shipping Weight	15.4 lb / 7 kg					11 lb / 5 kg		
Shipping Dimensions (W x D x H) (mm)	507 x 387 x 531					550 x 385 x 291		

Note: *SRP refers to the standard deviation for n replicate weightings (n≥10).

TABLE 9-3. SPECIFICATIONS (continued)

InCal Model	PX3202	PX4202	PX5202	PX6202	PX2201	PX4201		
ExCal Model	PX3202/E	PX4202/E	PX5202/E	PX6202/E	PX2201/E	PX4201/E	PX6201/E	PX8201/E
Capacity (g)	3200	4200	5200	6200	2200	4200	6200	8200
Readability d (g)	0.01	0.01	0.01	0.01	0.1	0.1	0.1	0.1
Repeatability (STDEV) (g)	0.01	0.01	0.01	0.01	0.1	0.1	0.1	0.1
Linearity (g)	±0.02	±0.02	±0.02	±0.02	±0.2	±0.2	±0.2	±0.2
Stabilization Time Typical (s)	1	1	1	1	1	1	1	1
Sensitivity Temperature Drift (PPM/K)	±3	±3	±3	±3	±10	±10	±10	±10
Typical Minimum Weight USP (USP K=2,U=0.10%)	20 g	20 g	20 g	20 g	200 g	200 g	200 g	200 g
Optimized Min-Weight (g) (USP, u=0.10%, k=2) SRP≤0.41d*	8.2 g	8.2 g	8.2 g	8.2 g	82 g	82 g	82 g	82 g
Units	Gram, Kilogram, Carat, Newton, Pound, Ounce, Ounce Troy, Grain, Pennyweight, Momme, Mesghal, Hong Kong Tael, Singapore Tael, Taiwan Tael, Tical (MM), Tola (India), 1 Custom unit							
Applications	Basic Weighing, Parts Counting, Percent Weighing, Dynamic Weighing, Density Determination							
Platform Size (diameter, mm)	180	180	180	180	180	180	180	180
Span Calibration Points (g)	2000, 3000	2000, 4000	3000, 5000	5000, 6000	1000, 2000	2000, 4000	5000, 6000	5000, 8000
Linearity Calibration Points (g)	0, 1500, 3000	0, 2000, 4000	0, 2500, 5000	0, 3000, 6000	0, 1000, 2000	0, 2000, 4000	0, 3000, 6000	0, 4000, 8000
Tare Range	To capacity by subtraction							
Power Supply	Power input: 100-240V ~ 200mA 50-60Hz 12-18VA Power output: 12 VDC 0.5A							
Assembled Dimensions (W x D x H) (mm)	209 x 321 x 98							
Communication	RS232, USB							
Operating Temperature Range	Operating conditions for ordinary lab application: +10°C to 30°C (operability guaranteed between +5°C and 40°C).							
Storage Temperature Range	Humidity: maximum relative humidity 80 % for temperatures up to 30°C, decreasing linearly to 50% relative humidity at 40°C							
Storage Conditions	-10°C to 60°C, humidity 10% to 90%, without condensation							
Net Weight	7.7 lb / 3.5 kg							
Shipping Weight	11 lb / 5 kg							
Shipping Dimensions (W x D x H) (mm)	550 x 385 x 291							

Note:*SRP refers to the standard deviation for n replicate weightings ($n \geq 10$).

TABLE 9-4. SPECIFICATIONS (continued)

InCal Approval Model	PX125DM	PX225DM	PX85M	PX124M	PX224M	PX323M	PX523M	PX623M
Capacity (g)	52/120	82/220	82	120	220	320	520	620
Readability d (g)	0.00001/ 0.0001	0.00001	0.00001	0.0001	0.0001	0.001	0.001	0.001
Verification Interval e (g)	0.001	0.001	0.001	0.001	0.001	0.01	0.01	0.01
Class	I	I	I	I	I	II	II	II
Repeatability (STDEV) (g)	0.00002/ 0.0001	0.00002/ 0.0001	0.00002	0.0001	0.0001	0.001	0.001	0.001
Linearity (g)	±0.0001	±0.0001	±0.0001	±0.0002	±0.0002	±0.002	±0.002	±0.002
Stabilization Time Typical (s)	10	10	10	3	3	2	2	2
Sensitivity temperature drift (PPM/K)	±0.8	±0.8	±0.8	±3	±3	±3	±3	±3
Typical Minimum Weight USP (USP K=2,U=0.10%)	20 mg	20 mg	20 mg	200 mg	200 mg	2 g	2 g	2 g
Optimized Min-Weight (g) (USP, u=0.10%, k=2) SRP ≤ 0.41d*	9 mg	9 mg	9 mg	82 mg	82 mg	0.82 g	0.82 g	0.82 g
Units	g, mg, ct							
Applications	Basic Weighing, Parts Counting, Percent Weighing, Dynamic Weighing, Density Determination							
Platform Size (diameter, mm)	80	80	80	90	90	120	120	120
Span Calibration Points (g)	50, 100	100, 200	50, 80	50, 100	100, 200	200, 300	300, 500	300, 500, 600
Linearity Calibration Points (g)	0, 50, 100	0, 100, 200	0, 40, 80	0, 50, 100	0, 100, 200	0, 150, 300	0, 250, 500	0, 300, 600
Tare Range	To capacity by subtraction							
Power Supply	Power input: 100-240V ~ 200mA 50-60Hz 12-18VA Power output: 12 VDC 0.5A							
Assembled Dimensions (W x D x H) (mm)	209 x 321 x 309							
Communication	RS232, USB							
Operating Temperature Range	Operating conditions for ordinary lab application: +10°C to 30°C (operability guaranteed between +5°C and 40°C).							
Storage Temperature Range	Humidity: maximum relative humidity 80% for temperatures up to 30°C, decreasing linearly to 50% relative humidity at 40°C							
Storage Conditions	-10°C to 60°C, humidity 10% to 90%, without condensation							
Net Weight	10 lb / 4.5 kg							
Shipping Weight	15.4 lb / 7 kg							
Shipping Dimensions (W x D x H) (mm)	507 x 387 x 531							

Note:

*SRP refers to the standard deviation for n replicate weightings (n ≥ 10).

TABLE 9-5. SPECIFICATIONS (continued)

InCal Approval Model	PX3202M	PX5202M	PX4201M
Capacity (g)	3200	5200	4200
Readability d (g)	0.01	0.01	0.1
Verification Interval e (g)	0.1	0.1	0.1
Class	II	II	II
Repeatability (STDEV) (g)	0.01	0.01	0.1
Linearity (g)	±0.02	±0.02	±0.2
Stabilization Time Typical (s)	1	1	1
Sensitivity temperature drift (PPM/K)	±3	±3	±10
Typical Minimum Weight USP (USP K=2,U=0.10%)	20 g	20 g	200 g
Optimized Min-Weight (g) (USP, u=0.10%, k=2) SRP ≤ 0.41d*	8.2 g	8.2 g	82 g
Units	g, kg, ct		
Applications	Basic Weighing, Parts Counting, Percent Weighing, Dynamic Weighing, Density Determination		
Platform Size (diameter, mm)	180	180	180
Span Calibration Points (g)	2000, 3000	3000, 5000	2000, 4000
Linearity Calibration Points (g)	0, 1500, 3000	0, 2500, 5000	0, 2000, 4000
Tare Range	To capacity by subtraction		
Power Supply	Power input: 100-240V ~ 200mA 50-60Hz 12-18VA Power output: 12 VDC 0.5A		
Assembled Dimensions (W x D x H) (mm)	209 x 321 x 98		
Communication	RS232, USB		
Operating Temperature Range	Operating conditions for ordinary lab application: +10°C to 30°C (operability guaranteed between +5°C and 40°C).		
Storage Temperature Range	Humidity: maximum relative humidity 80% for temperatures up to 30°C, decreasing linearly to 50% relative humidity at 40°C		
Storage Conditions	-10°C to 60°C, humidity 10% to 90%, without condensation		
Net Weight	7.7 lb / 3.5 kg		
Shipping Weight	11 lb / 5 kg		
Shipping Dimensions (W x D x H) (mm)	550 x 385 x 291		

Note:

*SRP refers to the standard deviation for n replicate weightings (n ≥ 10).

9.2 Drawings and Dimensions

Fully assembled dimensions

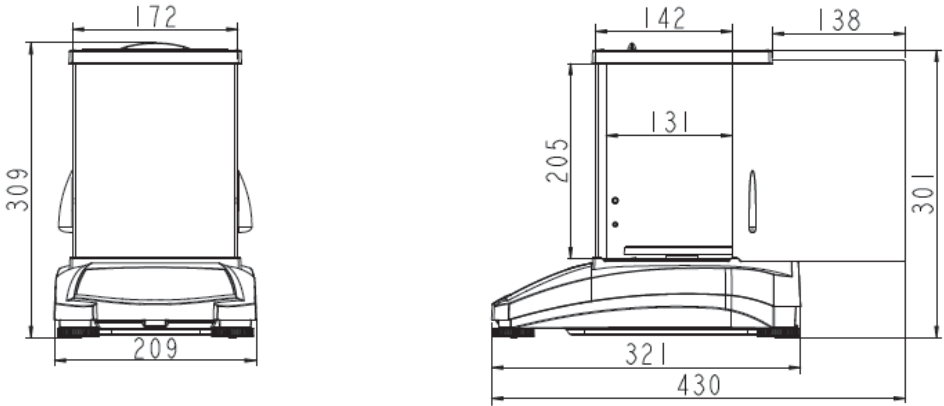

Figure 9-1 0.001 g / 0.0001 g model



Figure 9-2 0.01 g / 0.1 g model

9.3 Accessories

TABLE 9-5. ACCESSORIES

DESCRIPTION	PART NUMBER
Auxiliary display, AD7-RS	30472064
Density Kit	80253384
Calibrated Sinkers for Liquid Density Determination	83034024
USB Interface Cable	83021085
Security Device	80850043
RS232 Cable (25 pin)	80500524
RS232 Cable (9 pin)	80500525
Dust Cover	30093334
In-use Cover	30372546
Printer SF40A	30064202 (EU); 30064203 (AM)
Power Adapter for Balance	46001724

9.4 Communication

9.4.1 Interface Commands

Commands listed in the following table will be acknowledged by the balance.

Command Characters	Function
IP	Immediate Print of displayed weight (stable or unstable).
P	Print displayed weight (stable or unstable).
CP	Continuous Print.
SP	Print on Stability.
H	Enter Print Header Lines
Z	Same as pressing Zero Key
T	Same as pressing Tare Key.
xT***	Establish a preset Tare value in displayed unit. X = preset tare value. Sending 0T clears tare (if allowed).
PT	Prints Tare weight stored in memory.
ON	Brings out of Standby
OFF	Goes to Standby.
C	Begin Span Calibration
IC	Begin Internal Calibration, same as trigger from calibration menu.
AC	Abort Calibration. Attention: when LFT ON, the operation is not allowed.
PSN	Print Serial Number.
PV	Print terminal software version, base software version and LFT ON (if LFT is set ON).
x#	Set Counting APW (x) in grams. (must have APW stored)
P#	Print Counting application APW.
x%	Set Percent application reference weight (x) in grams. (must have reference weight stored)
P%	Print Percent application reference weight.
xRL	0 = disable response; 1 = enable response. This command only controls the "OK!" response.
xT	Pre-tare the container weight (x) in grams.

9.4.2 RS232 (DB9) Pin Connections

Diagram	Type	Description
	Interface type	Voltage interface conforming to EIA RS-232C/DIN 66020 (CCITT V24/V.28)
	Max. cable length	15 m
	Signal level	Output: +5 V ... +15 V (RL = 3 – 7kΩ) -5 V ... -15 V (RL = 3 - 7 kΩ) Input: +3 V ... +25 V -3 V ... -25 V
	Connector	Sub-D, 9-pole, female
	Operating mode	Full duplex
	Transmission mode	Bit-serial, asynchronous
	Transmission code	ASCII
	Baud rates	1200, 2400, 4800, 9600, 19200, 38400 (firmware selectable)
	Bits/parity	7-bit/even, 7-bit/odd, 7-bit/none, 8-bit/none (firmware selectable)
	Stop bits	Stop bit 1, 2
	Handshake	None, XON/XOFF, RTS/CTS (selectable)
	End-of-line	Not selectable

9.4.3 USB Interface

The Ohaus USB Interface is a unique solution to the problem of connecting a balance to a computer using a Universal Serial Bus (USB). USB devices are categorized into classes such as disk drives, digital cameras, printers, etc. Balances do not have a commonly used class so the Ohaus USB interface uses a generic interface based on the RS232 serial standard.

Data sent from the balance to a computer is in USB format. The USB data is directed to a *virtual port*. This port then appears as an RS232 port to the application program.

When sending a command from a computer to the balance, the application program sends a command to the *virtual port* as if it were an RS232 port. The computer then directs the command from the *virtual port* to the computers USB connector where the balance is connected. The port receives the USB signal and reacts to the command.

System Requirements

- PC running Windows 98®, Windows 98SE®, Windows ME®, Windows 2000®, Windows XP®, Windows 7® or Windows 8® (32-bit) or Windows 10®.
- Available USB port (Type A, 4-pin, female)

9.4.4 USB Connection

The balance's USB port terminates with a 4-pin, female, USB Type B connector.

A USB Cable (type B/male to type A/male) is required (not supplied).

1. Ensure that the balance is powered on and working properly.
2. Power on the computer and verify that its USB port is enabled and working properly.
3. Plug the cable's USB connectors into the computer's USB port and the balance's USB port. Windows® should detect a USB device and the New Hardware Wizard will be initialized.

Download from Ohaus' Website

1. The New Hardware Wizard guides you through the required steps to select the driver that is located on the website.

2. After clicking Finish, the virtual port should be ready for use. Windows® typically adds the virtual port in sequence after the highest number COM port. For example, on PC's equipped with up to 4 COM ports, the virtual port will be COM5.

When using the USB interface with programs that limit the number of COM port designations (e.g. Ohaus MassTracker allows only COM1, 2, 3, & 4), it may be necessary to assign one of these port numbers to the new virtual port.



Example of Windows XP Hardware Wizard

This can be done in the Port Settings of the Device Manager utility, found in the Windows Control Panel.

USB INPUT

The balance will respond to various commands sent via the interface adapter.

Terminate the following commands when with a [CR] or [CRLF]

PX Commands

- P** same as pressing Print
 - SP** print stable weight only
 - IP** immediate print of displayed weight (stable or unstable)
 - CP** Continuous print of weights
 - T** same as pressing Tare
 - Z** same as pressing Zero
 - PV** print software version
 - xT** establish a preset Tare value in displayed unit. X = preset tare value.
- Sending 0T clears tare (if allowed).

Auto-Print Operation

Once Auto-Print is activated in the menu, the balance will send data as required.





If there is data in the print buffer the printer will finish printing this data.

10. SOFTWARE UPDATES

Ohaus is continuously improving its balance software. To obtain the latest release, please contact your Authorized Ohaus Dealer or Ohaus Corporation.

11. COMPLIANCE

Compliance to the following standards is indicated by the corresponding mark on the product.

Mark	Standard
	This product complies with the applicable harmonized standards of EU Directives 2011/65/EU (RoHS), 2014/30/EU (EMC), 2014/35/EU (LVD) and 2014/31/EU (NAWI). The EU Declaration of Conformity is available online at www.ohaus.com/ce .
	This product complies with the EU Directive 2012/19/EU (WEEE) and 2006/66/EC (Batteries). Please dispose of this product in accordance with local regulations at the collecting point specified for electrical and electronic equipment. For disposal instructions in Europe, refer to www.ohaus.com/weee .
	EN 61326-1
	CAN/CSA-C22.2 No. 61010-1 UL Std. No. 61010-1

Important notice for PX/PXP/PJX/PR...M verified weighing instruments in the EU

When the instrument is used in trade or a legally controlled application it must be set up, verified and sealed in accordance with local weights and measures regulations. It is the responsibility of the purchaser to ensure that all pertinent legal requirements are met.

Weighing Instruments verified at the place of manufacture bear the following supplementary metrology marking on the descriptive plate.



Weighing Instruments to be verified in two stages have no supplementary metrology marking on the descriptive plate. The second stage of conformity assessment must be carried out by the applicable weights and measures authorities.

If national regulations limit the validity period of the verification, the user of the weighing instrument must strictly observe the re-verification period and inform the weights and measures authorities.

As verification requirements vary by jurisdiction, the purchaser should contact their local weights and measures office if they are not familiar with the requirements.

ISED Canada Compliance Statement:

This Class B digital apparatus complies with Canadian ICES-003.

ISO 9001 Registration

The management system governing the production of this product is ISO 9001 certified.

FCC Supplier Declaration of Conformity

Unintentional Radiator per 47CFR Part B
Trade Name: OHAUS CORPORATION
Model or Family identification: PX/PXP/PJX/PR

Issuing Party that Assembled the Product:

Ohaus Instruments (Changzhou) Co., Ltd.
2F, 22 Block, 538 West Hehai Road, Xinbei District, Changzhou
Jiangsu 213022
China
Phone: +86 519 85287270

Responsible Party – U.S. Contact Information:

Ohaus Corporation
7 Campus Drive, Suite 310
Parsippany, NJ 07054
United States
Phone: +1 973 377 9000
Web: www.ohaus.com

FCC Compliance Statement:

Note: This equipment has been tested and found to comply with the limits for a Class B digital device, pursuant to part 15 of the FCC Rules. These limits are designed to provide reasonable protection against harmful interference in a residential installation. This equipment generates, uses and can radiate radio frequency energy and, if not installed and used in accordance with the instructions, may cause harmful interference to radio communications. However, there is no guarantee that interference will not occur in a particular installation. If this equipment does cause harmful interference to radio or television reception, which can be determined by turning the equipment off and on, the user is encouraged to try to correct the interference by one or more of the following measures:

- Reorient or relocate the receiving antenna.
- Increase the separation between the equipment and receiver.
- Connect the equipment into an outlet on a circuit different from that to which the receiver is connected.
- Consult the dealer or an experienced radio/TV technician for help.

Changes or modifications not expressly approved by the party responsible for compliance could void the user's authority to operate the equipment.

LIMITED WARRANTY

Ohaus products are warranted against defects in materials and workmanship from the date of delivery through the duration of the warranty period. During the warranty period Ohaus will repair, or, at its option, replace any component(s) that proves to be defective at no charge, provided that the product is returned, freight prepaid, to Ohaus.

This warranty does not apply if the product has been damaged by accident or misuse, exposed to radioactive or corrosive materials, has foreign material penetrating to the inside of the product, or as a result of service or modification by other than Ohaus. In lieu of a properly returned warranty registration card, the warranty period shall begin on the date of shipment to the authorized dealer. No other express or implied warranty is given by Ohaus Corporation. Ohaus Corporation shall not be liable for any consequential damages.

As warranty legislation differs from state to state and country to country, please contact Ohaus or your local Ohaus dealer for further details.



WolfLabs

Pricing on any accessories shown can be found by keying the part number into the search box on our website.

The specifications listed in this brochure are subject to change by the manufacturer and therefore cannot be guaranteed to be correct. If there are aspects of the specification that must be guaranteed, please provide these to our sales team so that details can be confirmed.

www.wolflabs.co.uk

Tel : 01759 301142

Fax : 01759 301143

sales@wolflabs.co.uk

Please contact us if this literature doesn't answer all your questions.